

# siiora

*Preserving Nature's Most Wonderful Creation*

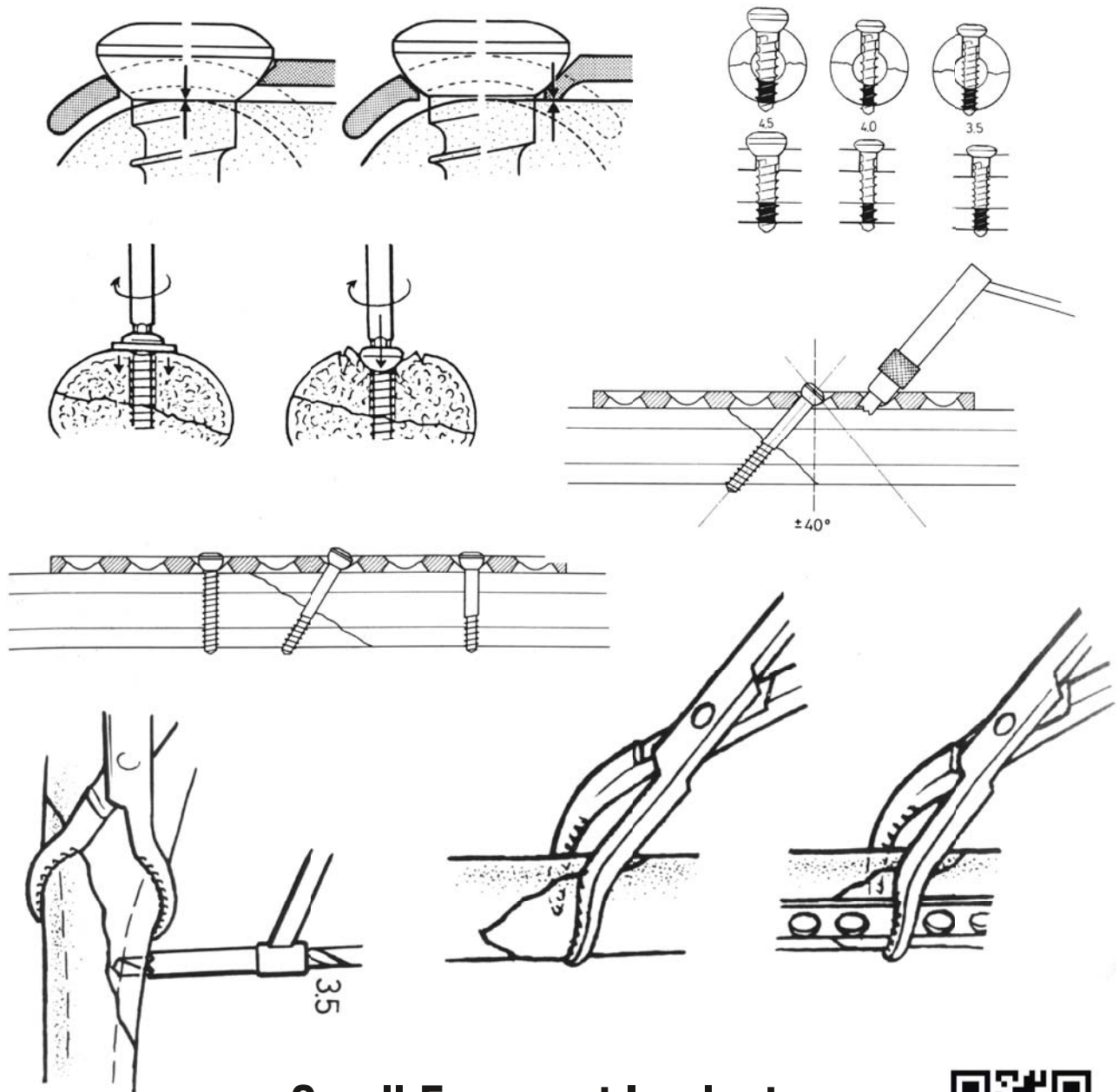

**Small Fragment Implants  
& Instruments (Non- Locking)**



**2.7mm Locking Head Screw - Self Tapping (HEXDRIVE)**

Cat No.	Length (mm)	Cat No.
Stainless Steel		Titanium
101.310	10	Ti.101.310
101.312	12	Ti.101.312
101.314	14	Ti.101.314
101.316	16	Ti.101.316
101.318	18	Ti.101.318
101.320	20	Ti.101.320
101.322	22	Ti.101.322
101.324	24	Ti.101.324
101.326	26	Ti.101.326
101.328	28	Ti.101.328
101.330	30	Ti.101.330
101.332	32	Ti.101.332
101.334	34	Ti.101.334
101.336	36	Ti.101.336
101.338	38	Ti.101.338
101.340	40	Ti.101.340
101.345	45	Ti.101.345
101.350	50	Ti.101.350



**2.7mm Locking Head Screw - Self Tapping (STARDRIVE)**

Cat No.	Length (mm)	Cat No.
Stainless Steel		Titanium
101.410	10	Ti.101.410
101.412	12	Ti.101.412
101.414	14	Ti.101.414
101.416	16	Ti.101.416
101.418	18	Ti.101.418
101.420	20	Ti.101.420
101.422	22	Ti.101.422
101.424	24	Ti.101.424
101.426	26	Ti.101.426
101.428	28	Ti.101.428
101.430	30	Ti.101.430
101.432	32	Ti.101.432
101.434	34	Ti.101.434
101.436	36	Ti.101.436
101.438	38	Ti.101.438
101.440	40	Ti.101.440
101.445	45	Ti.101.445
101.450	50	Ti.101.450



**2.7mm Cortical Screw - Self Tapping (HEXDRIVE)**

Cat No.	Length (mm)
<b>Stainless Steel</b>	
101.106	6
101.108	8
101.110	10
101.112	12
101.114	14
101.116	16
101.118	18
101.120	20
101.122	22
101.124	24
101.126	26
101.128	28
101.130	30
101.132	32
101.134	34
101.136	36
101.138	38
101.140	40
101.142	42



**2.7mm Cortical Screw - Self Tapping (STARDRIVE)**

Cat No.	Length (mm)
<b>Titanium</b>	
Ti.101.710	10
Ti.101.712	12
Ti.101.714	14
Ti.101.716	16
Ti.101.718	18
Ti.101.720	20
Ti.101.722	22
Ti.101.724	24
Ti.101.726	26
Ti.101.728	28
Ti.101.730	30



**Cortical Screw 3.5mm Dia.**

Cat No.	Length (mm)	Cat No.
Stainless Steel		Titanium
102.010	10	Ti.102.010
102.012	12	Ti.102.012
102.014	14	Ti.102.014
102.016	16	Ti.102.016
102.018	18	Ti.102.018
102.020	20	Ti.102.020
102.022	22	Ti.102.022
102.024	24	Ti.102.024
102.026	26	Ti.102.026
102.028	28	Ti.102.028
102.030	30	Ti.102.030
102.032	32	Ti.102.032
102.034	34	Ti.102.034
102.036	36	Ti.102.036
102.038	38	Ti.102.038
102.040	40	Ti.102.040
102.045	45	Ti.102.045
102.050	50	Ti.102.050
102.055	55	Ti.102.055
102.060	60	Ti.102.060



**Cancellous Screw 4.0mm Dia Short Thread**

Cat No.	Length (mm)	Cat No.
Stainless Steel		Titanium
104.010	10	Ti.104.010
104.012	12	Ti.104.012
104.014	14	Ti.104.014
104.016	16	Ti.104.016
104.018	18	Ti.104.018
104.020	20	Ti.104.020
104.022	22	Ti.104.022
104.024	24	Ti.104.024
104.026	26	Ti.104.026
104.028	28	Ti.104.028
104.030	30	Ti.104.030
104.035	35	Ti.104.035
104.040	40	Ti.104.040
104.045	45	Ti.104.045
104.050	50	Ti.104.050
104.055	55	Ti.104.055
104.060	60	Ti.104.060

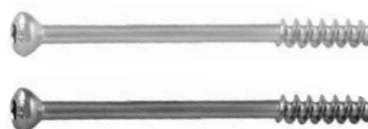

**Cortical Screw 3.5mm Dia - Self Tapping**

Cat No.	Length (mm)	Cat No.
Stainless Steel		Titanium
102.210	10	Ti.102.210
102.212	12	Ti.102.212
102.214	14	Ti.102.214
102.216	16	Ti.102.216
102.218	18	Ti.102.218
102.220	20	Ti.102.220
102.222	22	Ti.102.222
102.224	24	Ti.102.224
102.226	26	Ti.102.226
102.228	28	Ti.102.228
102.230	30	Ti.102.230
102.232	32	Ti.102.232
102.234	34	Ti.102.234
102.236	36	Ti.102.236
102.238	38	Ti.102.238
102.240	40	Ti.102.240
102.245	45	Ti.102.245
102.250	50	Ti.102.250
102.255	55	Ti.102.255
102.260	60	Ti.102.260



**Cancellous Screw 4.0mm Dia Full Thread**

Cat No.	Length (mm)	Cat No.
Stainless Steel		Titanium
105.010	10	Ti.105.010
105.012	12	Ti.105.012
105.014	14	Ti.105.014
105.016	16	Ti.105.016
105.018	18	Ti.105.018
105.020	20	Ti.105.020
105.022	22	Ti.105.022
105.024	24	Ti.105.024
105.026	26	Ti.105.026
105.028	28	Ti.105.028
105.030	30	Ti.105.030
105.035	35	Ti.105.035
105.040	40	Ti.105.040
105.045	45	Ti.105.045
105.050	50	Ti.105.050
105.055	55	Ti.105.055
105.060	60	Ti.105.060
105.065	65	Ti.105.065
105.070	70	Ti.105.070



**Washer for 4.0mm Cancellous Screws**

Cat No.	Dia (mm)	Inner Hole(mm)
Stainless Steel		
115.010	7.0	3.6



**Calcaneal Plate 3.5mm**

Cat No.	Length (mm)
Stainless Steel	
137.150	50
137.160	60
137.170	70



**One Third Tubular Plate 3.5mm**

Cat No.	Holes	Cat No.
Stainless Steel		Titanium
138.102	2	Ti.138.102
138.103	3	Ti.138.103
138.104	4	Ti.138.104
138.105	5	Ti.138.105
138.106	6	Ti.138.106
138.107	7	Ti.138.107
138.108	8	Ti.138.108
138.109	9	Ti.138.109
138.110	10	Ti.138.110
138.112	12	Ti.138.112



**One Third Tubular Plate with Collar**

Cat No.	Holes
Stainless Steel	
139.122	2
139.123	3
139.124	4
139.125	5
139.126	6
139.127	7
139.128	8
139.129	9
139.130	10
139.132	12



### 3.5mm DCP Plate

Thickness (3.5mm) Cat No.	Thickness (3.0mm) Cat No.	Holes Stainless Steel	Thickness (3.5mm) Titanium
140.102	140.502	2	Ti.140.102
140.103	140.503	3	Ti.140.103
140.104	140.504	4	Ti.140.104
140.105	140.505	5	Ti.140.105
140.106	140.506	6	Ti.140.106
140.107	140.507	7	Ti.140.107
140.108	140.508	8	Ti.140.108
140.109	140.509	9	Ti.140.109
140.110	140.510	10	Ti.140.110
140.112	140.512	12	Ti.140.112



### Small T- Plate , Right Angled Head 3 Holes

Cat No. Stainless Steel	Holes	Cat No. Stainless Steel
141.103	3	Ti.141.103
141.104	4	Ti.141.104
141.105	5	Ti.141.105
141.106	6	Ti.141.106
141.107	7	Ti.141.107
141.108	8	Ti.141.108
141.109	9	Ti.141.109
141.110	10	Ti.141.110



**Straight Pelvic Reconstruction Plate 3.5mm**

Cat No.	Holes
Stainless Steel	
144.105	5
144.106	6
144.107	7
144.108	8
144.109	9
144.110	10
144.112	12
144.114	14
144.116	16
144.118	18
144.120	20
144.122	22
144.124	24



**Clavical Plate for 3.5mm Screws**

Cat No.	Holes	Cat No.
Stainless Steel Left		Stainless Steel Right
860.106	6	860.116
860.108	8	860.118
860.110	10	860.120



**Curved Reconstruction Plate 3.5mm**

Cat No.	Holes	Cat No.
Stainless Steel		Titanium
144.306	6	Ti.144.306
144.308	8	Ti.144.308
144.309	9	Ti.144.309
144.310	10	Ti.144.310
144.312	12	Ti.144.312
144.314	14	Ti.144.314
144.316	16	Ti.144.316
144.318	18	Ti.144.318





**Small T - Plate, Oblique Angled for Right & Left Radius**

Cat No.	Holes	Cat No.
Stainless Steel		Titanium
142.103	3	Ti.142.103
142.104	4	Ti.142.104
142.105	5	Ti.142.105
142.106	6	Ti.142.106
142.107	7	Ti.142.107
142.108	8	Ti.142.108
142.109	9	Ti.142.109
142.110	10	Ti.142.110



**Y - Reconstruction Plate**

Cat No.	Holes	Size
Stainless Steel		
145.102	6	Small
145.103	9	Medium
145.104	12	Large



**LC - DCP for 3.5mm Screws**

Cat No.	Holes	Cat No.
Stainless Steel		Titanium
147.104	4	Ti.147.104
147.105	5	Ti.147.105
147.106	6	Ti.147.106
147.107	7	Ti.147.107
147.108	8	Ti.147.108
147.109	9	Ti.147.109
147.110	10	Ti.147.110
147.111	11	Ti.147.111
147.112	12	Ti.147.112



### Cloverleaf Plate

Cat No.	Holes
Stainless Steel	
146.103	3
146.104	4
146.105	5
146.106	6
146.107	7
146.108	8
146.109	9
146.110	10



### Hook Plate 3.5mm

Cat No.	Holes
Stainless Steel	
148.104	4
148.105	5
148.106	6
148.107	7
148.108	8
148.110	10



### Drill Bit - S.S. Quick Coupling End

Cat No.	Dia (mm)	Length (mm)
Stainless Steel		
260.200	2.0	100
260.205	2.0	125
260.250	2.5	115
260.254	2.5	180
260.255	2.5	200
260.270	2.7	125
260.275	2.7	200

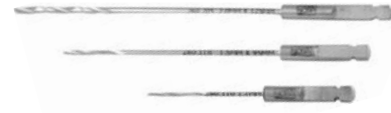

### Bone Tap Quick Coupling

Cat No.	Dia (mm)	Thread Length (mm)	Total Length (mm)
Stainless Steel			
264.025	3.5	50	110
264.035	3.5	50	175
264.037	4.0	85	110



### Drill Bit - Plain Shank / Jacob Chuck End

Cat No.	Dia (mm)	Length (mm)
Stainless Steel		
261.620	2.0	100
261.622	2.0	200
261.625	2.5	115
261.626	2.5	200
261.627	2.7	130
261.629	2.7	200

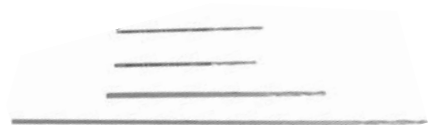

### Bone Tap with T - Handle

Cat No.	Dia (mm)	Thread Length (mm)	Total Length (mm)
Stainless Steel			
263.025	3.5	50	125
263.035	3.5	50	200
263.037	4.0	50	125



---

301.020 Hexagonal Screw Driver with Sleeve  
2.5mm Tip



---

301.025 Hexagonal Screw Driver with Self Holding  
Sleeve 2.5mm Tip



---

301.040 Small Hexagonal Screw Driver 2.5mm Tip



---

301.060 Screw Driver Shaft Q.C. End - 2.5mm Tip



---

302.010 Small Plate Bender (Pair)



---

302.050 Plate Bender for Reconstruction Plates  
for 3.5mm Plates



---

303.010 Small Depth Gauge



---

304.010 Small Neutral & Loaded Drill Guide



---

305.020 Counter Sink with T - Handle - 6.0mm Head  
(for 2.7, 3.5 & 4.0mm Screws)



---

305.050 Counter Sink - Q.C End - 6.0mm Head  
(for 2.7, 3.5 & 4.0mm Screws)



---

306.010 Quick Coupling Handle T - Type



---

306.020 Quick Coupling Handle (Fibre Handle)



---

306.030 Quick Coupling Adaptor for Drill Bits



---

306.040 Quick Coupling Tap handle - Long, T- Type



---

307.040 Tap Sleeve - 3.5mm



---

307.060 Drill & tap Sleeve Combined - 2.5 / 3.5mm



---

307.090 Insert Drill Guide Sleeve 2.5mm



---

322.020 Guide Wire Introducer with Four Pegs



---

322.030 K. Wire Bender



---

323.010 Wire Passer - Small



---

323.020 Wire Passer - Medium



---

324.010 Plier Cum Wire Bender



---

324.030 Plier Cum Wire Bender Cum Wire Cutter - 9"



---

324.050 Flat Nose Plier



328.010 Triple Drill Guide for 2.0mm Wires



328.020 Triple Drill Guide for 2.5mm Wires



324.020 Piler Cum Wire Bender Cum Wire Cutter - 6"



324.045 Wire Cutter - Double Action, Length - 250mm



325.010 Steinman Pin Introducer with S.S. Chuck & Key



326.010 Bone Awl with Eye Dia. 2.0mm



340.010 Self Centering Bone Holding Forceps 150mm

340.020 Self Centering Bone Holding Forceps 190mm



341.020 Reduction Forceps - Serrated - Ratchet Lock 170mm



## Small Fragment Implants & Instruments - (Non Locking)



---

341.030 Reduction Forceps - Serrated - Speed Lock  
Length - 170mm

341.040 Reduction Forceps - Serrated - Speed Lock  
Length - 200mm



---

342.020 Reduction Forceps -Pointed- Ratchet Lock  
Length 170mm

342.030 Reduction Forceps -Pointed- Ratchet Lock  
Length 200mm



---

342.040 Reduction Forceps- Pointed- Speed  
Lock - 170mm



---

379.010 Hohmann Retractor 6mm Wide, Short Narrow  
Point, 160mm Length



---

379.015 Hohmann Ratractor 8mm Wide, Short  
Narrow Point, 160mm Length



---

379.020 Hohmann Ratractor 15mm Wide,  
160mm Length



---

379.025 Hohmann Ratractor 8mm Wide, Short  
Narrow Tip, 220mm Length





400.010 Small Fragment Instrument Box with Two Trays for Instruments & One Tray for Screws with Screw Holding Forceps



400.025 Small Screw Box with Screw Tray & Screw Holding Forceps for 3.5mm Cortical, 3.5mm Cancellous & 4.0mm Cancellous



400.108 Graphic Aluminium Box for Small Fragment Instruments



400.117 Graphic Aluminium Box for Small Fragment Implant ( Non- Locking)

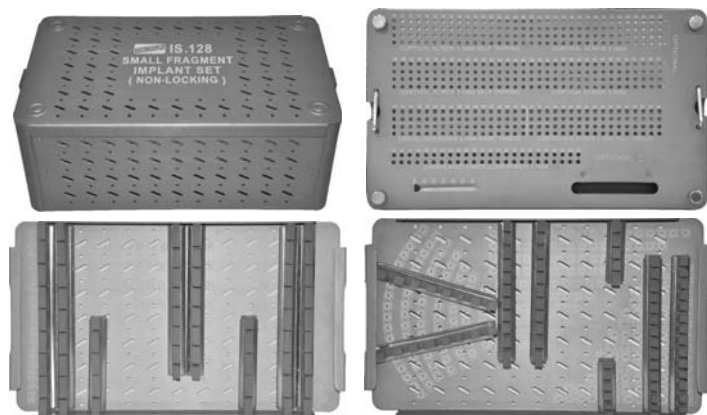

IS.128 Small Fragment Implant Set ( Non-Locking)

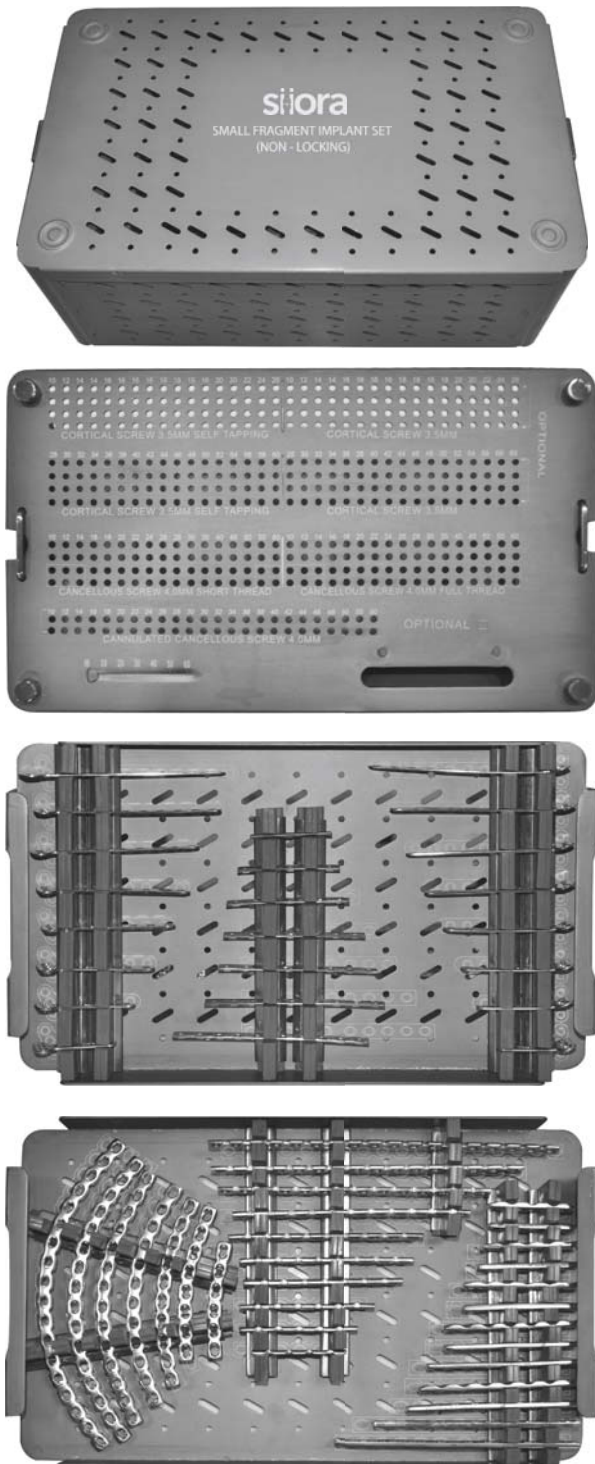

Cat No. IS.128	Small Fragment Implant set (Non - Locking)- Graphic Box	Units
139.124	One Third Tubular Plate with Collar 4 Holes	1
139.125	One Third Tubular Plate with Collar 5 Holes	1
139.126	One Third Tubular Plate with Collar 6 Holes	1
139.127	One Third Tubular Plate with Collar 7 Holes	1
139.128	One Third Tubular Plate with Collar 8 Holes	1
139.129	One Third Tubular Plate with Collar 9 Holes	1
139.130	One Third Tubular Plate with Collar 10 Holes	1
140.104	3.5mm DCP Plate (3.5mm Thickness) 4 Holes	1
140.105	3.5mm DCP Plate (3.5mm Thickness) 5 Holes	1
140.106	3.5mm DCP Plate (3.5mm Thickness) 6 Holes	1
140.107	3.5mm DCP Plate (3.5mm Thickness) 7 Holes	1
140.108	3.5mm DCP Plate (3.5mm Thickness) 8 Holes	1
140.109	3.5mm DCP Plate (3.5mm Thickness) 9 Holes	1
140.110	3.5mm DCP Plate (3.5mm Thickness) 10 Holes	1
140.111	3.5mm DCP Plate (3.5mm Thickness) 11 Holes	1
140.112	3.5mm DCP Plate (3.5mm Thickness) 12 Holes	1
147.104	(LC- DCP) for 3.5mm Screw 4 Holes	1
147.105	(LC- DCP) for 3.5mm Screw 5 Holes	1
147.106	(LC- DCP) for 3.5mm Screw 6 Holes	1
147.107	(LC- DCP) for 3.5mm Screw 7 Holes	1
147.108	(LC- DCP) for 3.5mm Screw 8 Holes	1
144.105	Straight Pelvic Reconstruction Plate 3.5mm 5 Holes	1
144.106	Straight Pelvic Reconstruction Plate 3.5mm 6 Holes	1
144.107	Straight Pelvic Reconstruction Plate 3.5mm 7 Holes	1
144.108	Straight Pelvic Reconstruction Plate 3.5mm 8 Holes	1
144.109	Straight Pelvic Reconstruction Plate 3.5mm 9 Holes	1
144.110	Straight Pelvic Reconstruction Plate 3.5mm 10 Holes	1
144.112	Straight Pelvic Reconstruction Plate 3.5mm 12 Holes	1
144.114	Straight Pelvic Reconstruction Plate 3.5mm 14 Holes	1
144.116	Straight Pelvic Reconstruction Plate 3.5mm 16 Holes	1
144.118	Straight Pelvic Reconstruction Plate 3.5mm 18 Holes	1
144.306	Curved Reconstruction Plate 3.5mm 6 Holes	1
144.308	Curved Reconstruction Plate 3.5mm 8 Holes	1
144.310	Curved Reconstruction Plate 3.5mm 10 Holes	1
144.312	Curved Reconstruction Plate 3.5mm 12 Holes	1
144.314	Curved Reconstruction Plate 3.5mm 14 Holes	1
144.316	Curved Reconstruction Plate 3.5mm 16 Holes	1
144.318	Curved Reconstruction Plate 3.5mm 18 Holes	1

Cat No. IS.128	Small Fragment Implant set (Non - Locking)- Graphic Box	Units
141.103	Small T - Plate Right Angled - Head 3 Holes, 3 Holes	1
141.104	Small T - Plate Right Angled - Head 3 Holes, 4 Holes	1
141.105	Small T - Plate Right Angled - Head 3 Holes, 5 Holes	1
141.106	Small T - Plate Right Angled - Head 3 Holes, 6 Holes	1
141.107	Small T - Plate Right Angled - Head 3 Holes, 7 Holes	1
141.108	Small T - Plate Right Angled - Head 3 Holes, 8 Holes	1
141.109	Small T - Plate Right Angled - Head 3 Holes, 9 Holes	1
141.110	Small T - Plate Right Angled - Head 3 Holes, 10 Holes	1
142.103	Small T - Plate Oblique Angled for Right & Left Radius 3 Holes	1
142.104	Small T - Plate Oblique Angled for Right & Left Radius 4 Holes	1
142.105	Small T - Plate Oblique Angled for Right & Left Radius 5 Holes	1
142.106	Small T - Plate Oblique Angled for Right & Left Radius 6 Holes	1
142.107	Small T - Plate Oblique Angled for Right & Left Radius 7 Holes	1
142.108	Small T - Plate Oblique Angled for Right & Left Radius 8 Holes	1
142.109	Small T - Plate Oblique Angled for Right & Left Radius 9 Holes	1
142.110	Small T - Plate Oblique Angled for Right & Left Radius 10 Holes	1
102.210	Cortical Screw 3.5mm Dia. - Self Tapping - Legnth 10mm	4
102.212	Cortical Screw 3.5mm Dia. - Self Tapping - Legnth 12mm	4
102.214	Cortical Screw 3.5mm Dia. - Self Tapping - Legnth 14mm	8
102.216	Cortical Screw 3.5mm Dia. - Self Tapping - Legnth 16mm	16
102.218	Cortical Screw 3.5mm Dia. - Self Tapping - Legnth 18mm	16
102.220	Cortical Screw 3.5mm Dia. - Self Tapping - Legnth 20mm	8
102.222	Cortical Screw 3.5mm Dia. - Self Tapping - Legnth 22mm	4
102.224	Cortical Screw 3.5mm Dia. - Self Tapping - Legnth 24mm	4
102.226	Cortical Screw 3.5mm Dia. - Self Tapping - Legnth 26mm	4
102.228	Cortical Screw 3.5mm Dia. - Self Tapping - Legnth 28mm	4
102.230	Cortical Screw 3.5mm Dia. - Self Tapping - Legnth 30mm	4
102.232	Cortical Screw 3.5mm Dia. - Self Tapping - Legnth 32mm	4
102.234	Cortical Screw 3.5mm Dia. - Self Tapping - Legnth 34mm	4
102.236	Cortical Screw 3.5mm Dia. - Self Tapping - Legnth 36mm	4
102.238	Cortical Screw 3.5mm Dia. - Self Tapping - Legnth 38mm	4
102.240	Cortical Screw 3.5mm Dia. - Self Tapping - Legnth 40mm	4
102.242	Cortical Screw 3.5mm Dia. - Self Tapping - Length 42mm	4
102.244	Cortical Screw 3.5mm Dia. - Self Tapping - Length 44mm	4
102.246	Cortical Screw 3.5mm Dia. - Self Tapping - Length 46mm	4
102.248	Cortical Screw 3.5mm Dia. - Self Tapping - Length 48mm	4
102.250	Cortical Screw 3.5mm Dia. - Self Tapping - Legnth 50mm	4
102.252	Cortical Screw 3.5mm Dia. - Self Tapping - Length 52mm	4
102.254	Cortical Screw 3.5mm Dia. - Self Tapping - Length 54mm	4
102.256	Cortical Screw 3.5mm Dia. - Self Tapping - Legnth 56mm	4
102.258	Cortical Screw 3.5mm Dia. - Self Tapping - Length 58mm	4
102.260	Cortical Screw 3.5mm Dia. - Self Tapping - Legnth 60mm	4

Cat No. IS.128	Small Fragment Implant set (Non - Locking)- Graphic Box	Units
104.010	Cancellous Screw 4.0mm Dia. Short - Thread Length 10mm	2
104.012	Cancellous Screw 4.0mm Dia. Short - Thread Length 12mm	2
104.014	Cancellous Screw 4.0mm Dia. Short - Thread Length 14mm	2
104.016	Cancellous Screw 4.0mm Dia. Short - Thread Length 16mm	4
104.018	Cancellous Screw 4.0mm Dia. Short - Thread Length 18mm	4
104.020	Cancellous Screw 4.0mm Dia. Short - Thread Length 20mm	4
104.022	Cancellous Screw 4.0mm Dia. Short - Thread Length 22mm	4
104.024	Cancellous Screw 4.0mm Dia. Short - Thread Length 24mm	4
104.026	Cancellous Screw 4.0mm Dia. Short - Thread Length 26mm	4
104.028	Cancellous Screw 4.0mm Dia. Short - Thread Length 28mm	4
104.030	Cancellous Screw 4.0mm Dia. Short - Thread Length 30mm	4
104.035	Cancellous Screw 4.0mm Dia. Short - Thread Length 35mm	4
104.040	Cancellous Screw 4.0mm Dia. Short - Thread Length 40mm	4
104.045	Cancellous Screw 4.0mm Dia. Short - Thread Length 45mm	4
104.050	Cancellous Screw 4.0mm Dia. Short - Thread Length 50mm	4
104.055	Cancellous Screw 4.0mm Dia. Short - Thread Length 55mm	2
104.060	Cancellous Screw 4.0mm Dia. Short - Thread Length 60mm	2
105.010	Cancellous Screw 4.0mm Dia. Full - Thread Length 10mm	2
105.012	Cancellous Screw 4.0mm Dia. Full - Thread Length 12mm	2
105.014	Cancellous Screw 4.0mm Dia. Full - Thread Length 14mm	2
105.016	Cancellous Screw 4.0mm Dia. Full - Thread Length 16mm	4
105.018	Cancellous Screw 4.0mm Dia. Full - Thread Length 18mm	4
105.020	Cancellous Screw 4.0mm Dia. Full - Thread Length 20mm	4
105.022	Cancellous Screw 4.0mm Dia. Full - Thread Length 22mm	4
105.024	Cancellous Screw 4.0mm Dia. Full - Thread Length 24mm	4
105.026	Cancellous Screw 4.0mm Dia. Full - Thread Length 26mm	4
105.028	Cancellous Screw 4.0mm Dia. Full - Thread Length 28mm	4
105.030	Cancellous Screw 4.0mm Dia. Full - Thread Length 30mm	4
105.035	Cancellous Screw 4.0mm Dia. Full - Thread Length 35mm	4
105.040	Cancellous Screw 4.0mm Dia. Full - Thread Length 40mm	4
105.045	Cancellous Screw 4.0mm Dia. Full - Thread Length 45mm	4
105.050	Cancellous Screw 4.0mm Dia. Full - Thread Length 50mm	4
105.055	Cancellous Screw 4.0mm Dia. Full - Thread Length 55mm	2
105.060	Cancellous Screw 4.0mm Dia. Full - Thread Length 60mm	2

## Small Fragment Implants & Instruments - (Non Locking)



Cat No.	Small Fragment Instrument set- Graphic Box	Units
IS.114		
260.250	Drill Bit - S.S. - Quick Coupling End Dia. 2.5mm X 115mm Long	2
260.320	Drill Bit - S.S. - Quick Coupling End Dia. 3.2mm X 130mm Long	2
263.025	Bone Tap with T - Handle Dia. 3.5mm Thread Length 50mm, Total Length 125mm	2
263.030	Bone Tap with T -Handle Dia. 3.5mm -Cancellous, Thread Length 50mm, Total Length 125mm	2
301.040	Small Hexagonal Screw Driver 2.5mm Tip	1
301.060	Screw Driver Shaft, Q.C. End 2.5mm Tip	1
302.010	Small Plate Bender - Pair	1
303.010	Small Depth Gauge	1
304.010	Small Neutral & Loaded Drill Guide	1
305.020	Counter Sink with T - Handle - 6.0mm Head ( for 2.7, 3.5 & 4.0 Screws)	1
306.010	Quick Coupling Handle T-Type	1
307.060	Drill & Tap Sleeve Combined - 2.5/3.5mm	1
307.090	Insert Drill Sleeve 2.5mm	1
322.030	K.Wire Bender	1
324.010	Plier Cum Wire Bender	1
341.010	Reduction forceps - Serrated Ratchet Lock - 140mm	1
342.010	Reduction Forceps - Pointed Ratchet Lock - 140mm	1
340.020	Self Centering Bone Holding Forceps 190mm	1
371.000	Sharp Hook	1
379.015	Hohmann Retractor 8mm Wide, Short Narrow Point, 160mm Length	2
379.020	Hohmann Retractor 15mm Wide, 160mm Length	2
381.008	Periosteal Elevator - Straight 8mm	1
400.108	Graphic Aluminium Box for Small Fragment Instruments	1



Cat No. IS.012	Small Fragment Implants Set	Units
102.210	Cortical Screw 3.5mm Dia. - Self Tapping Legnth 10mm	4
102.212	Cortical Screw 3.5mm Dia. - Self Tapping Legnth 12mm	4
102.214	Cortical Screw 3.5mm Dia. - Self Tapping Legnth 14mm	8
102.216	Cortical Screw 3.5mm Dia. - Self Tapping Legnth 16mm	4
102.218	Cortical Screw 3.5mm Dia. - Self Tapping Legnth 18mm	8
102.220	Cortical Screw 3.5mm Dia. - Self Tapping Legnth 20mm	4
102.222	Cortical Screw 3.5mm Dia. - Self Tapping Legnth 22mm	4
102.224	Cortical Screw 3.5mm Dia. - Self Tapping Legnth 24mm	4
102.226	Cortical Screw 3.5mm Dia. - Self Tapping Legnth 26mm	4
102.228	Cortical Screw 3.5mm Dia. - Self Tapping Legnth 28mm	4
102.232	Cortical Screw 3.5mm Dia. - Self Tapping Legnth 32mm	4
102.236	Cortical Screw 3.5mm Dia. - Self Tapping Legnth 36mm	4
102.240	Cortical Screw 3.5mm Dia. - Self Tapping Legnth 40mm	4
103.012	Cancellous Screw 3.5mm Dia. Length 12mm	2
103.014	Cancellous Screw 3.5mm Dia. Length 14mm	2
103.016	Cancellous Screw 3.5mm Dia. Length 16mm	2
103.018	Cancellous Screw 3.5mm Dia. Length 18mm	2
103.020	Cancellous Screw 3.5mm Dia. Length 20mm	2
103.022	Cancellous Screw 3.5mm Dia. Length 22mm	2
103.024	Cancellous Screw 3.5mm Dia. Length 24mm	2
103.028	Cancellous Screw 3.5mm Dia. Length 28mm	2
103.030	Cancellous Screw 3.5mm Dia. Length 30mm	2
103.035	Cancellous Screw 3.5mm Dia. Length 35mm	2
103.040	Cancellous Screw 3.5mm Dia. Length 40mm	2
103.045	Cancellous Screw 3.5mm Dia. Length 45mm	2
103.050	Cancellous Screw 3.5mm Dia. Length 50mm	2
103.055	Cancellous Screw 3.5mm Dia. Length 55mm	2
103.060	Cancellous Screw 3.5mm Dia. Length 60mm	2
115.010	Washer for 4.0mm Cancellous Screw	6
139.123	One Third Tubular Plate with Collar 3 Holes	1
139.124	One Third Tubular Plate with Collar 4 Holes	2
139.125	One Third Tubular Plate with Collar 5 Holes	2

## Small Fragment Implants & Instruments - (Non Locking)



139.126	One Third Tubular Plate with Collar 6 Holes	2
139.127	One Third Tubular Plate with Collar 7 Holes	1
139.128	One Third Tubular Plate with Collar 8 Holes	1
104.012	Cancellous Screw 4.0mm Dia. Short - Thread Length 12mm	2
104.014	Cancellous Screw 4.0mm Dia. Short - Thread Length 14mm	2
104.016	Cancellous Screw 4.0mm Dia. Short - Thread Length 16mm	2
104.018	Cancellous Screw 4.0mm Dia. Short - Thread Length 18mm	2
104.020	Cancellous Screw 4.0mm Dia. Short - Thread Length 20mm	2
104.022	Cancellous Screw 4.0mm Dia. Short - Thread Length 22mm	2
104.024	Cancellous Screw 4.0mm Dia. Short - Thread Length 24mm	2
104.028	Cancellous Screw 4.0mm Dia. Short - Thread Length 28mm	2
104.030	Cancellous Screw 4.0mm Dia. Short - Thread Length 30mm	2
104.035	Cancellous Screw 4.0mm Dia. Short - Thread Length 35mm	2
104.040	Cancellous Screw 4.0mm Dia. Short - Thread Length 40mm	2
104.045	Cancellous Screw 4.0mm Dia. Short - Thread Length 45mm	2
104.050	Cancellous Screw 4.0mm Dia. Short - Thread Length 50mm	2
104.055	Cancellous Screw 4.0mm Dia. Short - Thread Length 55mm	2
104.060	Cancellous Screw 4.0mm Dia. Short - Thread Length 60mm	2
140.105	3.5mm DCP Plate (3.5mm Thickness) 5 Holes	1
140.106	3.5mm DCP Plate (3.5mm Thickness) 6 Holes	2
140.107	3.5mm DCP Plate (3.5mm Thickness) 7 Holes	2
140.108	3.5mm DCP Plate (3.5mm Thickness) 8 Holes	1
140.110	3.5mm DCP Plate (3.5mm Thickness) 10 Holes	1
141.103	Small T - Plate Right Angled - Head 3 Holes, 3 Holes	1
141.104	Small T - Plate Right Angled - Head 3 Holes, 4 Holes	1
142.103	Small T - Plate Oblique Angled for Right & Left Radius 3 Holes	1
142.104	Small T - Plate Oblique Angled for Right & Left Radius 4 Holes	1
185.116	Kirschner Wire with Trocar Tip Dia. 1.0mm, Length 150mm	10
185.140	Kirschner Wire with Trocar Tip Dia. 1.5mm, Length 150mm	10
185.156	Kirschner Wire with Trocar Tip Dia. 2.0mm, Length 150mm	10
400.010	Small Fragment Instrument Box with Two Trays for Instruments & One Tray for Screws with Screw Holding Forceps	1







Siora Surgicals Private Limited

Manufacturer of:  
Trauma & Spine Implants

 **Regd. & Corporate Office**  
WZ-1, Phool Bagh, Rampura  
Delhi - 110035, INDIA

 **Office Land line:**  
+91 11 28316116 , 17, 18

 **Manufacturing Unit:**  
1792, HSIIDC Indl. Estate  
RAI District, Sonapat  
Haryana- 131029, INDIA

 [www.siora.com](http://www.siora.com)  
 [impex@siora.net](mailto:impex@siora.net)  
 [exports@siora.net](mailto:exports@siora.net)